

FRYERS

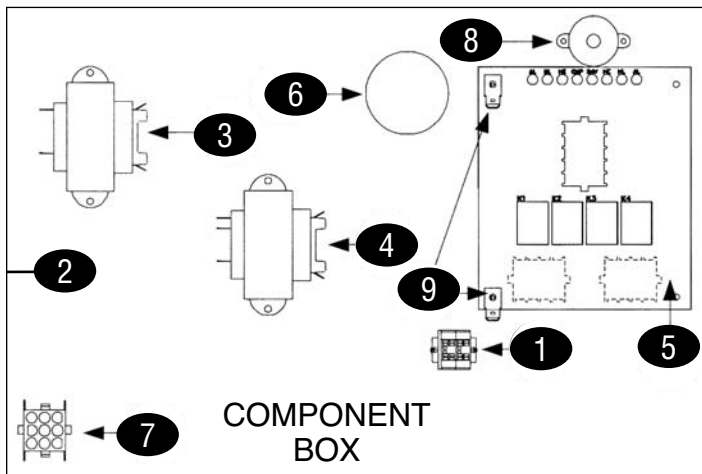
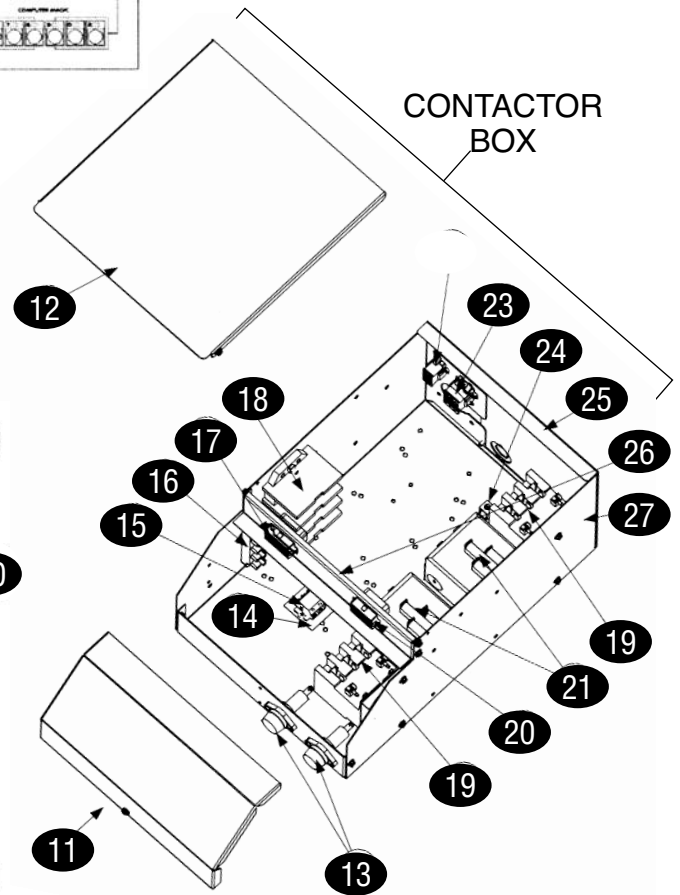
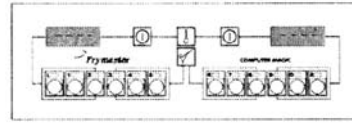
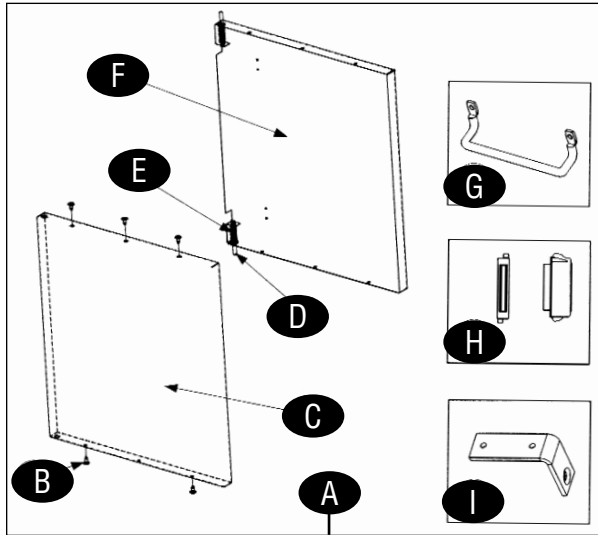

KEY	PART #	DESCRIPTION	KEY	PART #	DESCRIPTION
A	FM806-6545SP	Door Assembly, RH	13	FM807-0922	Fuse Holder, HPS
B	FM809-0266	Screw, 10-1/2"	n/s	FM807-2278	Fuse, 20A
C	FM824-0137SP	Door Panel	n/s	FM807-0501	Fuse Block, 3-Pole Buss, 22k W
D	FM806-4487SP	Door Pin w/keeper	n/s	FM807-2240	Fuse, Buss 60A, 300VAC, 22k W
n/s	FM809-0193	Flat Washer, Door Pin Bushing, Nylon, 1/4"	n/s	FM807-2865	Block Support, Fuse, 22k W
E	FM826-1343	Spring, Door Hinge, pkg of 10	14	FM816-0217	Insulating Paper, Terminal Block, CE
F	FM900-2485	Door Liner	15	FM810-1164	Terminal Block
G	FM810-1422	Door Handle, Wireform	16	FM807-1973	Terminal Post
H	FM810-1105	Door Magnet, FPPH/FMPH	17	FM806-7199SP	Wiring Assembly, Full Vat, C1
I	FM810-1508	Door Hinge, Bracket	18	FM807-2464	Power Block, Delta
J	FM826-2333	Computer Assembly, Full Vat	n/s	FM807-2465	Power Block, WYE
1	FM810-1164	Terminal Block Wiring Assembly	19	FM810-1202	Contactor, 3-Pole, 40A/24V
2	FM806-8244	Component Box/Stud Assembly	20	FM800-7191SP	Wiring Assembly, Dual & Full Vat, C2
3	FM807-2191	Transformer, 20VA, 208-240V/12V	21	FM807-1071	Contactor, Mercury, 24VAC, 30A, 3PL
	FM807-0979	Transformer, 208-240V/12V	n/s	FM806-7186SP	Wiring Assembly, Left, Full Vat
4	FM807-0680	Transformer, w/out Fuse, 240V/24V	n/s	FM807-2136	Connector, 6-Pin Female
	FM807-2180	Transformer, w/Fuse, 208-240V/24V	n/s	FM807-2135	Connector, 6-Pin Male
5	FM826-2256	Interface Board	23	FM806-7185SP	Wiring Assembly, Right, Dual & Full Vat
	FM806-3850	Interface Board, Rear Mounted Probes	n/s	FM807-2138	Connector, 9-Pin Female
	FM826-2257	Interface Board, Solid State (for Triac Models)	n/s	FM807-2137	Connector, 9-Pin Male
6	FM807-1084	Bushing	24	FM807-0070	Terminal, Ground Lug
7	FM806-6854SP	Wiring Assembly, Transformer	25	FM900-5447	Back Cover, Contactor Box
8	FM806-3660SP	Sound Device	26	FM900-5782	Bracket, Connector, Common Electric
9	FM826-1337	Terminal Tab, pkg of 5	27	FM900-5444	Box, Contactor, Common Electric
10	FM806-2071	Wire Harness, Computer/Interface Board			
11	FM900-5445	Front Cover, Contactor Box			
12	FM900-5446	Top Cover, Contactor Box			